

# Fiberoptic Electric Field Sensor



## Features

- No metal parts
- Passive
- Miniature
- Optical fiber readout
- High shock/vibration resistance
- High sensitivity
- Wide bandwidth
- High damage threshold

## Applications

- PAA radar tests
- Antennas characterization
- Plasma process control
- Military Active Denial Systems
- HPM, HRI and EMP systems

The EOFS Electric-field sensor provides an analog response to the electrical field from few tens Hz to 40GHz. It is based on packaging an electro-optical crystal with a dual fiber collimator, consisting entirely of non-metallic materials, having an ultra-high electrical damage threshold (>10 MV/m and 10W/cm<sup>2</sup> power density) and harsh environment compatibility, including temperature, pressure, liquid, X-rays, and gamma rays. Since it does not disturb the field, the measurement has high fidelity. We produce horizontal and vertical sensors to detect electrical fields in 3D. We offer several package configurations for general use, liquid immersion, vacuum chamber compatibility, permittivity matching, and 3D vector sensing in customization. Custom design is our specialty.

The readout unit (PEFS) is sold separately. The operation principle is launching a laser beam through optic fibers and detecting the optical intensity changes on function of E-field. The readout has a multichannel capability. The system is well suited to remotely and non-intrusively measure electric fields in demanding applications.

## Specifications

Parameter		Min	Typical	Max	Unit
Frequency Bandwidth	Ultra-high		18	40	GHz
	High		7		GHz
	Low			500	MHz
Sensitivity <sup>[1]</sup>	Ultra-high frequency		100		mV/m-Hz <sup>1/2</sup>
	High frequency		60		mV/m-Hz <sup>1/2</sup>
	Low frequency		60		mV/m-Hz <sup>1/2</sup>
Cut-off Frequency	Ultra-high frequency		10		MHz
	High frequency		10		MHz
	Low frequency		30 <sup>[2]</sup>		Hz
Maximum detectable E-field <sup>[3]</sup>			200		kV/m
Damage E-field				5	MV/m
Package Dimension			See design		

### Notes:

- [1] Defined by measuring with a 1550nm laser and 100MHz
- [2] Sensitivity drops significantly at f < 50Hz
- [3] Possible to be increased up to 2MV/m, please contact us

**Note:** The specifications provided are for general applications with a cost-effective approach. If you need to narrow or expand the tolerance, coverage, limit, or qualifications, please [click this link](#):

**Legal notices:** All product information is believed to be accurate and is subject to change without notice. Information contained herein shall legally bind Agiltron only if it is specifically incorporated into the terms and conditions of a sales agreement. Some specific combinations of options may not be available. The user assumes all risks and liability whatsoever in connection with the use of a product or its application.

Rev 09/19/24

# Fiberoptic Electric Field Sensor

## DATASHEET

### Mechanical Dimensions (mm)

#### Standard Package 1

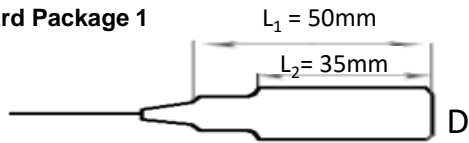

D (Standard) = 8mm in diameter

#### Mini Package 2 (Longitudinal E-field sensing)

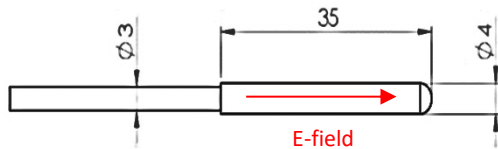

D (small) = 4mm in diameter

#### Package 4 (Lateral E-field sensing)

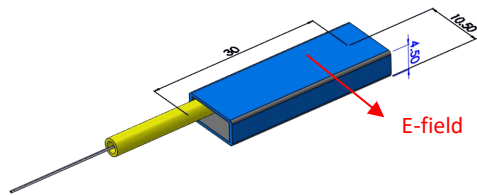

#### Mini Package 3 (Lateral E-field sensing)\*

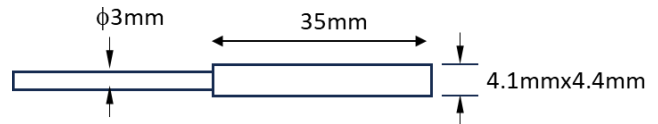

\*Special order with long LT

#### Package 5 for 3-axis sensor only

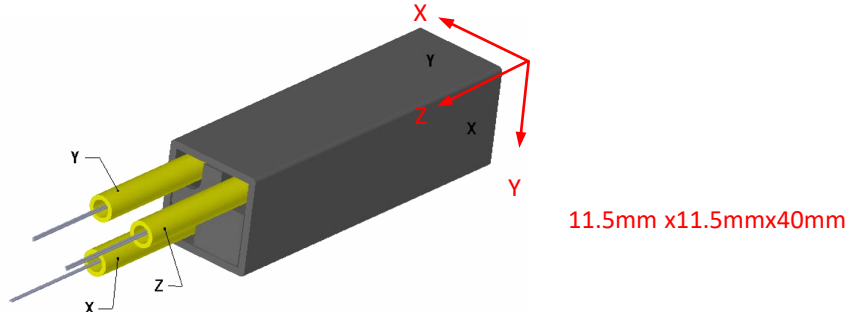

### Application Note

#### 1) System Configuration of E-field Measurements

The E-field detection by using a fiber optic sensor (EOFS) and the readout system is straightforward, as shown below. The Photonic E-field measurement system (PEFS, sale separately) is composed of one laser diode (LD), one photodetector (PD) with the amplifier, and an oscilloscope or spectrum analyzer (not shown in the following schematic diagram).

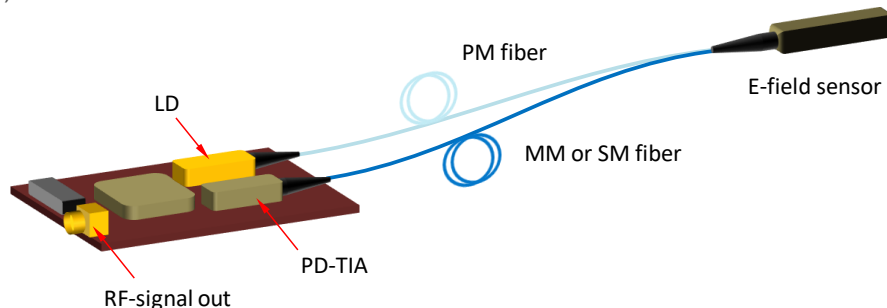

# Fiberoptic Electric Field Sensor

## DATASHEET

The fiber-coupled LD is connected to the fiber E-field sensor, and the output of the probing laser from the sensor is connected to the PD in the readout module (PEFS). The electric signal from PD should be connected to either the oscilloscope or the spectrum analyzer for measuring the E-field. Because the output electric signal is highly dependent on the laser power, PD, and TIA performances, the measurement set-up must be calibrated for the quantitative measurements.

### 2) EOFS Calibration

For characterizing/calibrating the fiber optic sensor EOFS and the module, the TEM cell or parallel electrodes must be used, as schematically shown in Fig.2 and Fig.3 respectively.

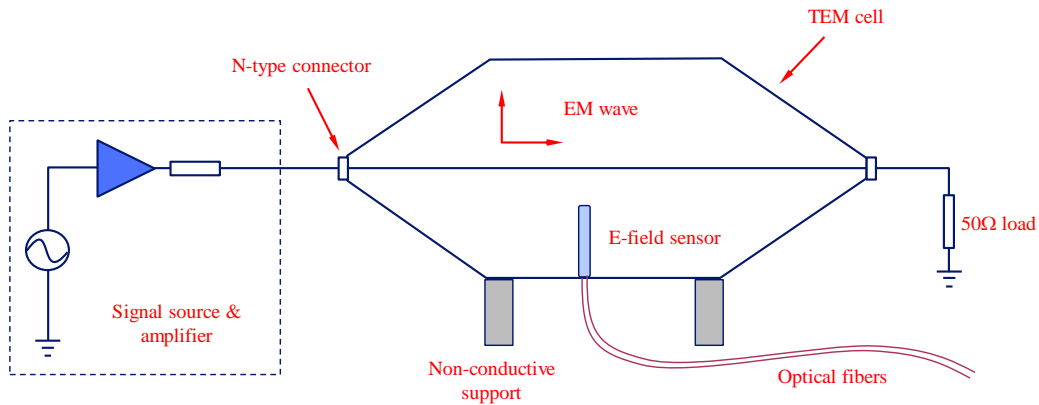

Figure 2: Schematic diagram of EOFS ( high frequency) set up in TEM cell

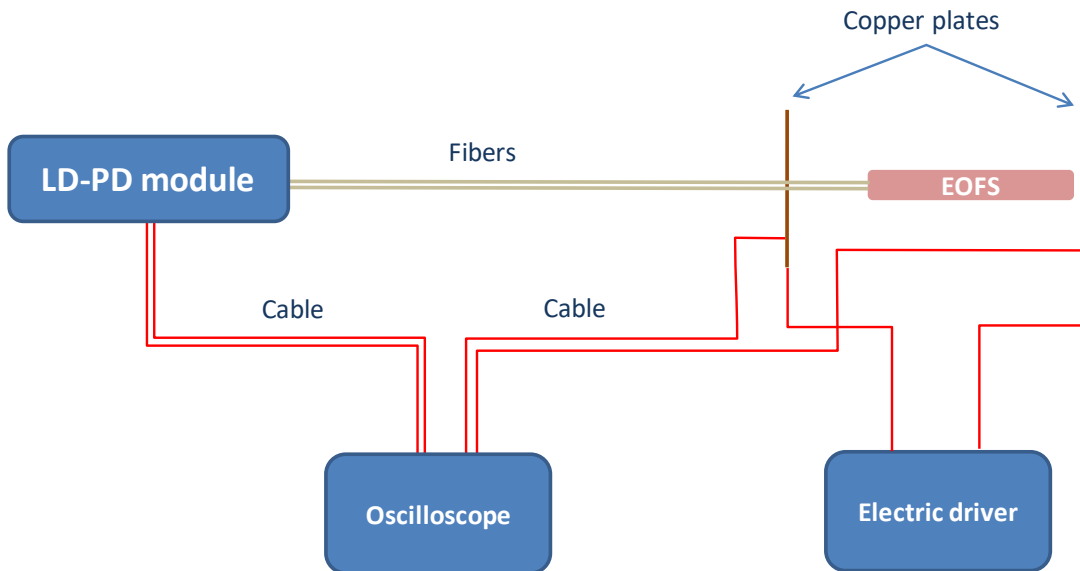

Figure 3: Schematic diagram of low frequency E-field measurement

# Fiberoptic Electric Field Sensor

## DATASHEET

### 3) System Calibration

The sensor's responsivity highly depends on the frequency and the system parameters, such as the laser power, and the PD's responsivity and TIA gain in the laser readout module (PEFS). So, the onsite calibration in the measurement system of EOFS and PEFS is highly recommended to quantitatively measure the E-field strength accurately, once the whole system is set up.

The electric signal can be expressed approximately on the function of E-field strength as follows.

$$\Delta V(f) = \alpha E(f) + \beta E^2(f)$$

Where  $\alpha, \beta$  are the coefficients to be determined through the calibration test, which depend on the input laser power and TIA gain.  $E$  is the electric field strength (V/m),  $f$  is the frequency of the E-field.

### Ordering Information

Prefix	Type	Configuration	Package <sup>[4]</sup>	Fiber Cover	Fiber Type (input)	Fiber Type (output)	Fiber Length	Connector
<b>EOFS-</b>	LNGITUD <sup>[2]</sup> 7GHz = 11 LNGITUD <sup>[2]</sup> 500MHz = 12 LNGITUD <sup>[2]</sup> 18GHz = 18 LNGITUD <sup>[2]</sup> 40GHz = 04 LNGITUD <sup>[2]</sup> Special = 00 LTRL <sup>[3]</sup> 7GHz = L1 LTRL <sup>[3]</sup> 500MHz = L2 LTRL <sup>[3]</sup> 18GHz = L8 LTRL <sup>[3]</sup> 40GHz = L4 LTRL <sup>[3]</sup> Special = L0 3-axis & 7GHz = C1 3-axis & 500MHz = C2 3-axis & 18GHz = C8 3-axis & 40GHz = C4	Ambient = 1 Liquid = 2 Vacuum = 3	Standard = 1 Small = 2 Package 4 = 4 Package 5 = 5 Ultrasmall <sup>[5]</sup> = 3 Special = 0	Bare fiber = 1 900µm tube = 3 Special = 0	Panda PM = 1 Special = 0	SMF-28 = 2 Special = 0	0.25m = 1 0.5m = 2 1.0m = 3 Special = 0	FC/PC = 2 FC/APC = 3 SC/PC = 4 SC/APC = 5 Special = 0

[1]. For frequencies ≥ 10GHz, the output fiber must be SMF-28.

[2]. Longitudinal E-field

[3]. Lateral E-field

[4]. Small package 2 for longitudinal EOFS; package 4 for lateral EOFS, package 5 for 3-axis EOFS.

[5]. Ultra-Small package for lateral EOFS: 4.0mmx4.2mm x 50mm.

Red is specially made with long lead time.

**Note:**

- 1) Additional fiber cable extensions can be purchased through this link: <https://agiltron.com/category/optical-fiber-patch-jump-cables/> or
- 2) The extended length of fibers in one protection cable is available too, please call us.